

TRANSGLOBAL

225 North Patterson Street • Carey, Ohio 43316
Phone: 419-396-9079 • Fax: 419-396-9832

Toll-Free: 1-877-TRNSGLBL (877-876-7452)
visit us on the web at... www.transglobaldoor.com

***"Worldwide Supplier Of Roll-Up Doors & Parts
For The Transportation Industry!"***

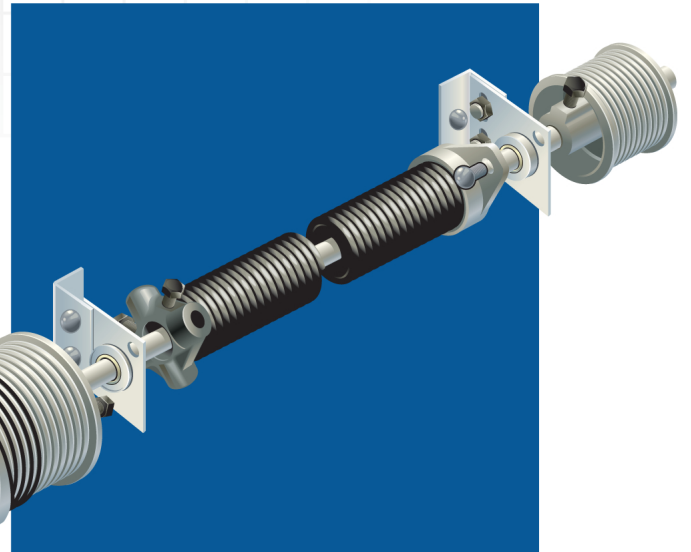
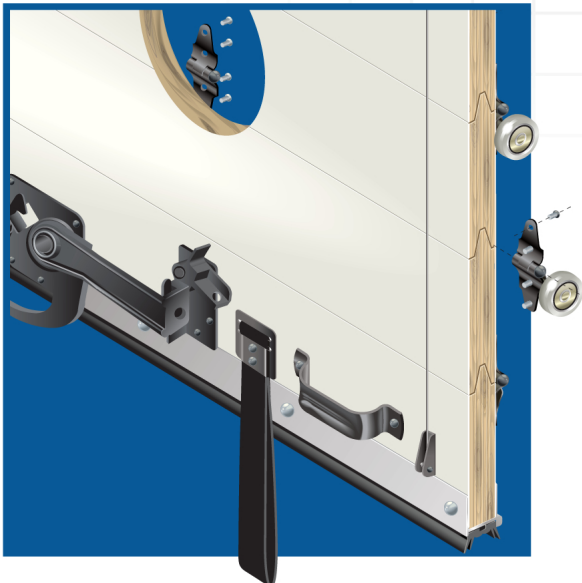



TG-15



Description: Center Hinge
 Specs: Black E-Coat
 Other: W-15

TG-5600

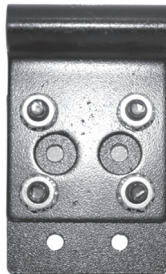

Description: HD Bottom Fixture
 Specs: 4" Long
 Black E-Coat
 Other: W-5600

TG-HD1209-A-SS



Description: HD Roller Hinge Assembly
 Specs: Stainless Steel
 Other:
 PATENT# 7,681,284B1

TG-61352



Description: Bottom Fixture
 Specs: Galvanized
 Other: T-61352 W-4003

TG-HD15-SS



Description: HD Center Hinge
 Specs: Stainless Steel
 Other:

TG-69035

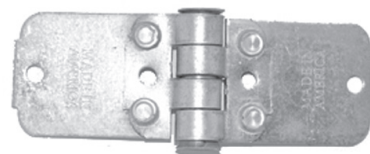

Description: End Hinge
 Specs: Galvanized
 Other: T-69035 W-4007

TG-69433

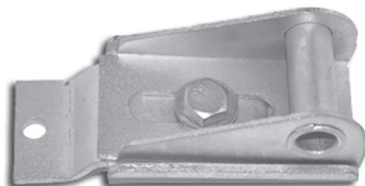

Description: Top Fixture
 Assembly Complete
 Specs: Zinc
 Other: T-69433 W-4039



HINGES & FIXTURES

TG-61196



Description: Center Hinge

Specs: Galvanized

Cross Reference: T-61196,
W-4012

TG-9723-size



Description: Pull Strap Assembly

Specs: Black E-Coat Retainer
Specify length

Cross Reference: T-80844 ,
W-9723

TG-6944



Description: Top Closure
Assembly -Complete

Specs: Black E-Coat

Cross Reference: W-6944

TG-5803



Description: HD CABLE
ANCHOR BRACKET

Specs: BLACK E-COAT

Cross Reference: W-5803

TG-70438



Description: Dual Roller Top
Fixture Assembly

Specs: Black E-Coat

Cross Reference: T-70438

TG-5600-2.5

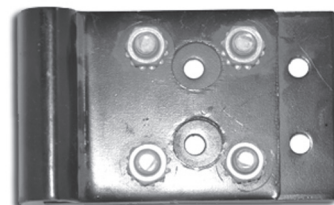

Description: HD Bottom Fixture
Assembly

Specs: 2.5" Long for 3/4" Dry-
Freight 2" Rollers - Black E-Coat
Cross Reference:

TG-HD5600-2.5

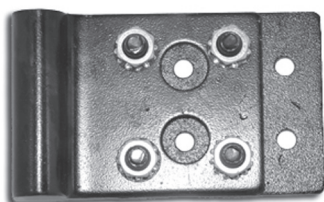

Description: HD Bottom Fixture
Assembly

Specs: 2.5" Long for 1/2" Road
Ready Composite Doors
Black E-Coat

TG-2804



Description: Latch Plate

Specs: Steel

Cross Reference: W- 2804

**TG-1715
TG-61401**



Description: Lift Handle

Specs: 1715 Black E-Coat
69401 Zinc

Cross Reference: W-1715
T-61401



TG-1264



Description: Base-Top Closure Assembly
Specs: Black E-Coat
Cross Reference: W-1264

TG-1209-A



Description: Roller Hinge Complete
Specs: Black E-Coat
Cross Reference: W-1209A

TG-1208



Description: Hinge Cover- Roller Hinge
Specs: Black E-Coat
Cross Reference: W-1208

TG-6943



Description: Slide- Top Closure Assembly
Specs: Black E-Coat
Cross Reference: W-6943

TG-69431

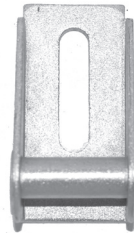

Description: Slide- Top Fixture Assembly
Specs: Zinc
Cross Reference: T-69431
W-4038

TG-HD1209-A



Description: HD Roller Hinge Assembly
Specs: Black E-Coat
Cross Reference: PATENT # 7,681,284B1

TG-HD15

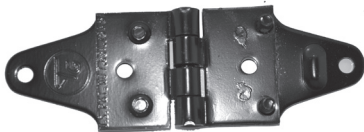

Description: HD Center Hinge
Specs: Black E-Coat
Cross Reference:



HINGES & FIXTURES

TG-1370

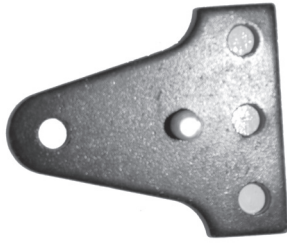

Description: Bottom Bracket
Stud Plate
Specs: Black E-Coat
Cross Reference: W-1370

TG-1021



Description: Bottom Roller Shaft
Cover
Specs: Black E-Coat
Cross Reference: W-1021

TG-69432

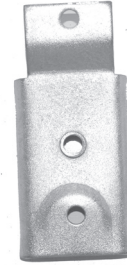

Description: Base- Top Fixture
Assembly
Specs: Zinc
Cross Reference: T-69432
W-4051

TG-1371



Description: Complete Bottom
Bracket with Cover
Specs: Black E-Coat
Cross Reference: W-1371

TG-1207

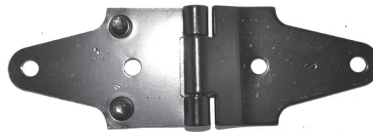

Description: Roller Hinge- Only
Specs: Black E-Coat
Cross Reference: W-1207

TG-70093

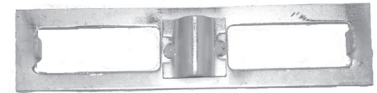

Description: Latch Plate Box
Specs: Steel
Cross Reference: T- 70093

TG-69832
TG-7575



Description: Pull Strap Retainer
Specs: Zinc - T-69832
Black E-Coat - W-7575
Cross Reference:

TG-69964-1
TG-69964-2

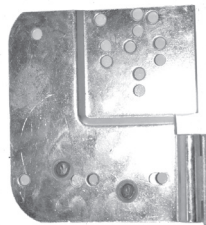

Description: HD Bottom Fixture
Assembly
Specs: Zinc
Cross Reference: T-69964-1 CS
T-69964-2 -RS

TG-61204
TG-4004

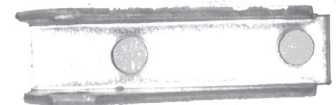

Description: Cable Anchor
Bracket
Specs Zinc-T-61204
Black E-Coat -W-4004
Cross Reference:



TG-77



Description: Lock Assembly
 Specs: Black E-Coat
 Cross Reference: W- 77

TG-7515



Description: Lock Keeper
 Specs: Black E-Coat
 Cross Reference: W- 7515

TG-4077



Description: Lock Assembly- Flat Backplate
 Specs: Black E-Coat
 Cross Reference: W-4077

TG-69571



Description: MS Lock Assembly
 Specs: Black E-Coat
 Cross Reference: T-69571

TG-69571-Z

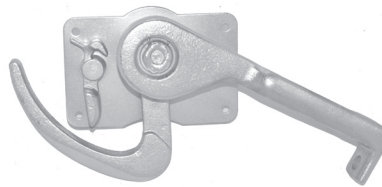

Description: MS Lock Assembly
 Specs: Zinc Plated
 Cross Reference: T-69571

TG-69572



Description: Lock Keeper
 Specs: Black E-Coat
 Cross Reference: T-69572

TG-69572-Z

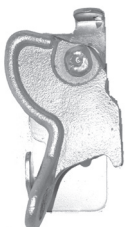

Description: Lock Keeper
 Specs: Zinc Plated
 Cross Reference: T-69572

TG-69602



Description: Pad Lock Keeper
 Specs: Zinc
 Cross Reference: T-69602

TG-70472-1000
TG-70472-2000

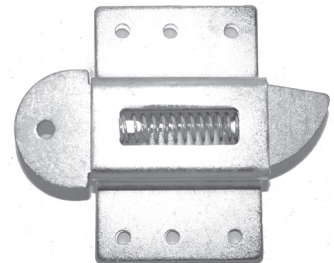

Description: End Latch Assembly
 Specs: Zinc
 Cross Reference:
 70472-1000 (CS)
 70472-2000 (RS)



LOCKS

TG-8368

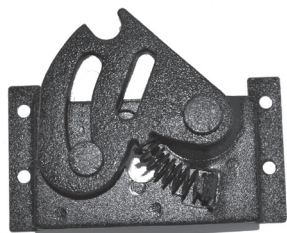

Description: Side Latch Lock Fan Latch (RS)
 Specs: Black E-Coat
 Cross Reference: W-8368

TG-8369

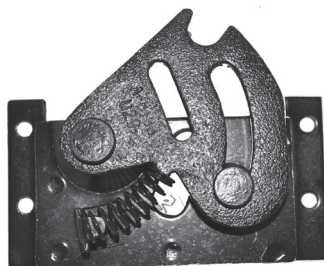

Description: Side Latch Lock- Fan Latch (CS)
 Specs: E-Coat
 Cross Reference: W-8369

TG001

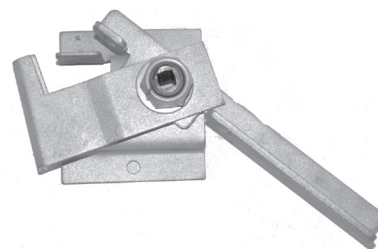

Description: Center Control
 Specs: Zinc
 Cross Reference: T-69959

TG-7730



Description: Safety Latch-Quick Release
 Specs: Black E-Coat
 Cross Reference: W-7730

TG-61223



Description: Safety Chain Back-plate
 Specs: Zinc
 Cross Reference: TG-61223
 W-4110

**TG-69000
 TG-69017**



Description: L-Handle
 Keyed - 69017
 Non-Keyed 69000
 Specs: Chrome
 Cross Reference:

TG-61229



Description: Safety Chain
 Specs: Zinc
 Cross Reference: T-61229

TG-61229-SS



Description: Safety Chain - Stainless Steel
 Specs:
 Cross Reference:



TG-59310



Description: Hex Winding Bar
Specs: Universal- One End for
WH Dual Spring and the other for
T-Single Spring
Cross Reference:

TG-70306



Description: Aluminum Fork-Lift
Plate
Specs: 16" - 36"
Cross Reference:
T-70306

TG-39000-1008
TG-39000-1012



Description: Door Lube
Specs: 16 oz Cans
Cross Reference:
T-39000-1008 per Can
T-39000-1012 12-per Case

TG-69085

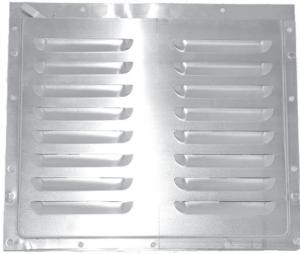

Description: Polar Vent
Specs:
Cross Reference:
T-69085

ROLLERS & BEARINGS



TG-61174



Description: 1" Steel Roller
 Specs: Zinc
 Cross Reference: T-61774
 W-4027

TG-2996



Description: 2" Steel Roller
 Specs: Zinc
 Cross Reference: T-70224
 W-2996

TG-3228



Description: 2" Nylon Roller
 Specs:
 Cross Reference: W-3228

TG-70305



Description: 1" Precision
 Machined Sealed Roller
 Specs: Zinc
 Cross Reference: T-70305

TG-2996-HD



Description: 2" Steel Roller
 Specs: Exact WH 2996 Replacement
 Cross Reference: 2996

TG-60002



Description: 2" Premium Nylon
 Roller
 Specs: Sealed Micro Bearing
 Cross Reference:

TG-60001



Description: 1" Premium Nylon
 Roller
 Specs: Sealed Micro Bearing
 Cross Reference:

TG-59206

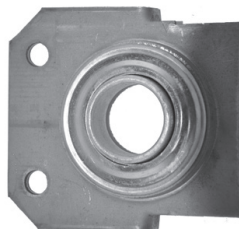

Description: Bearing Bracket-
 Shallow Header
 Specs: Steel
 Cross Reference: T-59206

TG-51038-99



Description: 1" Bearing Only
 Specs: Zinc
 Cross Reference:



TG-51038

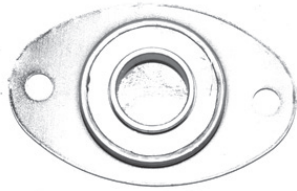

Description: Bearing Assembly

Specs: Zinc

Cross Reference: T-51038

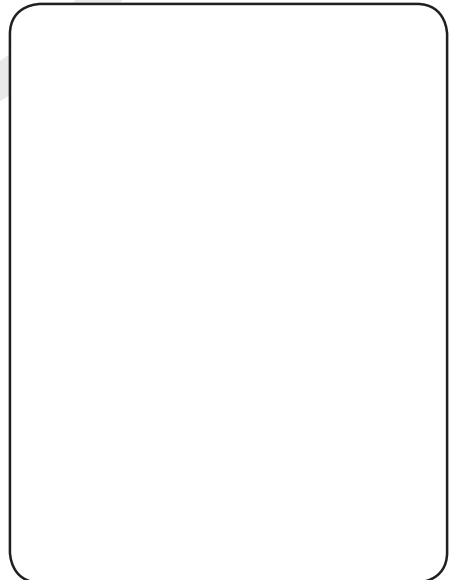
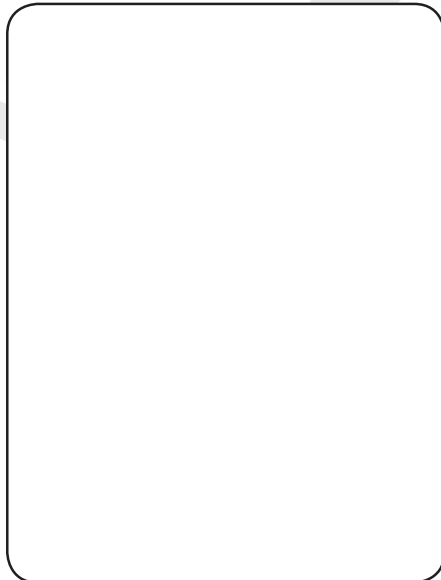
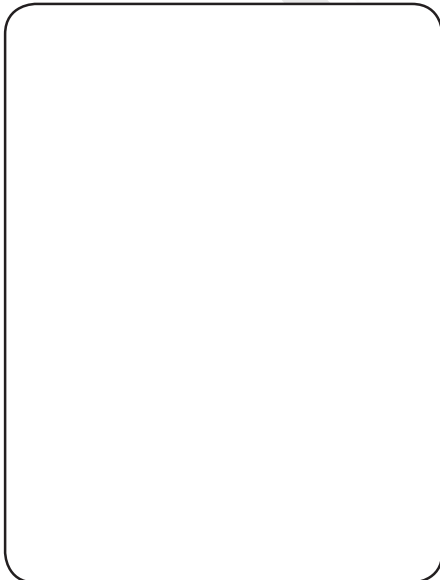
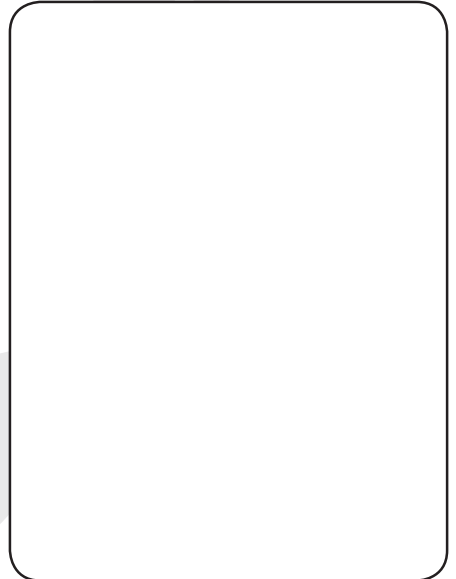
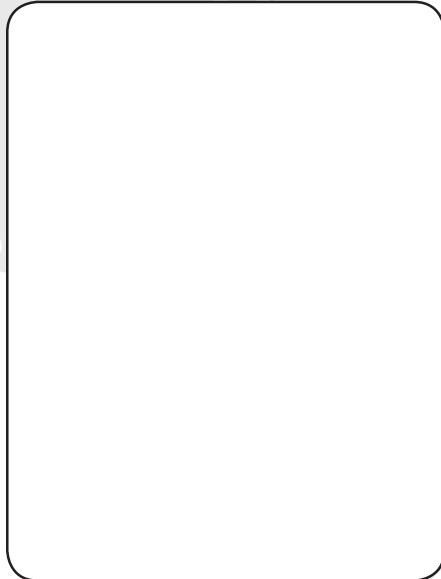
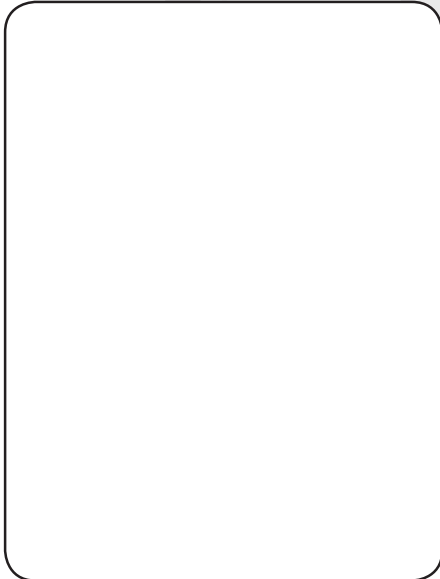
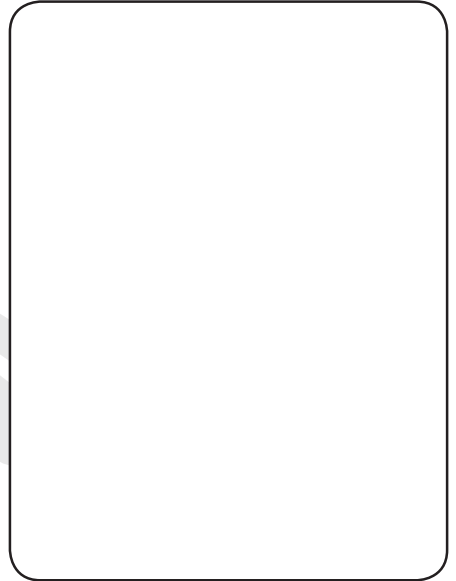

SEALS & RETAINERS



TG-83



Description: 2" Track Stop
Specs: Rubber
Cross Reference: W-83

TG-70105

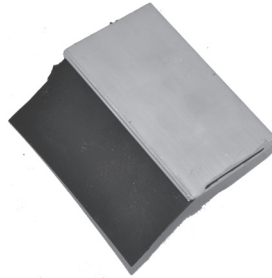

Description: Secondary Side Seal Assembly
Specs: Belted Rubber
Cross Reference: T-70105

TG-6203-6237

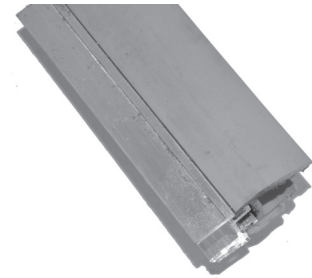

Description: Tru-Sealer 3/4" Swing Door Gasket and Retainer
Specs: Assembled
Cross Reference: 6203-6237

TG-69770

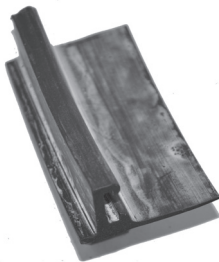

Description: Header Seal
Specs: Rubber
Cross Reference: T-69770

TG-70001-.5



Description: Top Seal
Specs: 1/2" Road Ready Composite Door
Cross Reference:

TG-61398



Description: 1" Track Stop
Specs: Rubber
Cross Reference: T-61398

TG-70131



Description: Dual Lip Side Seal
Specs: Rubber
Cross Reference: T-70131

TG-45985



Description: GD Sponge Seal
Specs
Cross Reference: GD-45985

TG-60402701



Description: Framing Aluminum Door Edge
Specs: Swing Door
Cross Reference:



TG-80840



Description: Bottom Seal
 Specs: Rubber
 Cross Reference: T-80840
 W-3257

TG-1676

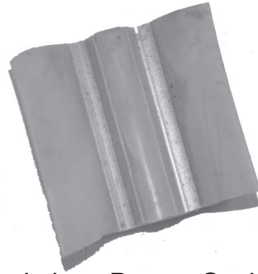

Description: Bottom Seal
 Specs: For 1801 Retainer
 Cross Reference:
 W-1676

TG-8280-2

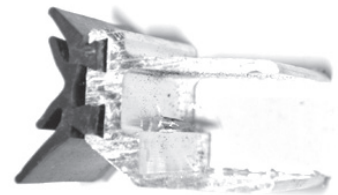

Description: Bottom U-Channel-
 Aluminum (5735 seal)
 Specs:
 Cross Reference: W-8280-2

TG-75004-.5



Description: Bottom Seal for 1/2"
 Extreme Duty Composite Doors
 Specs: Vinyl
 Cross Reference:

TG-7145

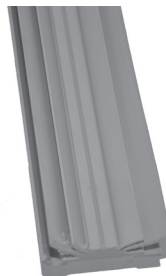

Description: Bottom Seal for
 2 1/8" CLDSVR - 7144 retainer
 Specs: Vinyl
 Cross Reference: W- 7145

TG-7144

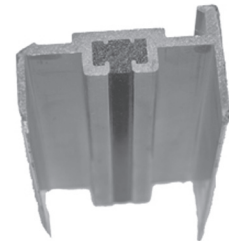

Description: Bottom Channel-
 2 1/8" CLDSVR- Aluminum
 Specs: 97"
 Cross Reference:
 W-7144

TG-70337

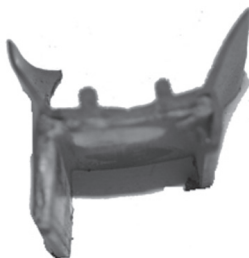

Description: Replaceable Bottom
 Seal
 Specs: Vinyl
 Cross Reference: T-70337

TG-61390



Description: Side Seal
 Specs: Rubber
 Cross Reference: T-61390
 W-4019

TG-5423



Description: Vinyl Side Seal for
 5/16" track spacing
 Specs:
 Cross Reference: W-5423

SEALS & RETAINERS



TG-70231



Description: Side Brush Seal Assembly -Brush and retainer
Specs: 1" Brush or 1 1/2" Brush
White or Black Brush

TG-70001



Description: Top Panel Seal Retainer
Specs: Rubber and Retainer
Cross Reference: T-70001

TG-69922

TG-69922



Description: Side Seal Assembly
Specs: Aluminum Retainer and Belted Rubber - White or Black
Cross Reference: T-69922
W-



TG-2526

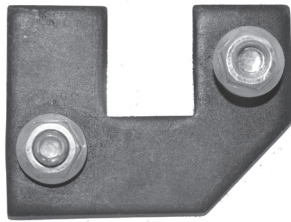

Description: Balancer Bracket
Clamp
Specs: Steel
Cross Reference: W- 2526

TG-2524



Description: Balancer Bracket
(Roadside)
Specs: Steel
Cross Reference: W-2524

TG-2525

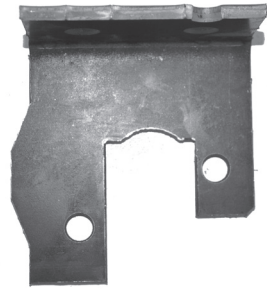

Description: Balancer Bracket
Center
Specs: Steel
Cross Reference: W-2525

TG-2523

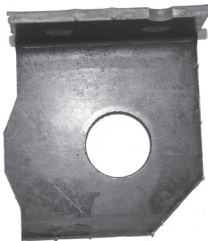

Description: Balancer Bracket
(Curbside)
Specs: Steel
Cross Reference: W=2523

TG-2518



Description: Winding Cone
2 3/16" I.D.
Specs:
Cross Reference: W-2518

TG-2547 TG-2547-A
TG-2548 TG-2548-A



Description: Cable Drum & Bear-
ing Assembly
W-2547-CS W- 2548-RS
TG-2547-A Aluminum -CS
TG-2548-A Aluminum -RS

TG-7549
TG-7550



Description: Winding Cone
2 5/8" I.D. Metal
Specs: Black E-Coat
Cross Reference:
7549- (CS) 7550 - (RS)

TG-59157-3
TG-59157-4



Description: Cable Drum
Specs: Aluminum
Cross Reference:
59157-3 (LH)
59157-4 (RH)

TG-7096
TG-7097



Description: Cable Drum
Metal 2 5/8" I.D.
Black E-Coat
Cross Reference:
7096 -(CS) 7097- (RS)

SPRING COMPONENTS



TG-59158



Description: Spring Winding Plug
1 3/4" I.D.
Specs:
Cross Reference: T-59158
W-4050

TG-51043



Description: Spring Anchor Plug
1 3/4" I.D.
Specs:
Cross Reference: T-51043
W-4025

TG-59159



Description: Spring Winding Plug
2 1/2" I.D.
Specs:
Cross Reference: T-59159

TG-59024



Description: Spring Anchor Plug
2 1/2" I.D.
Specs:
Cross Reference: T-59024

TG-59191



Description: Spring Anchor Plug
1 3/4" I.D. Shallow Header
Specs:
Cross Reference: T-59191

TG-59180



Description: Spring Winding Plug
1 3/4" I.D. Shallow Header
Specs:
Cross Reference: T-59180

TG-51036-1
TG-51036-2



Description: Spring Anchor
Bracket
Specs: Steel
T-51036-1-CS T-51036-2-RS
W-4028-RS W-4029-CS

TG-69951

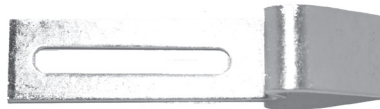

Description: Lock Catch
Specs: Zinc
Cross Reference: T-69951

INTERMEDIATE PANELS

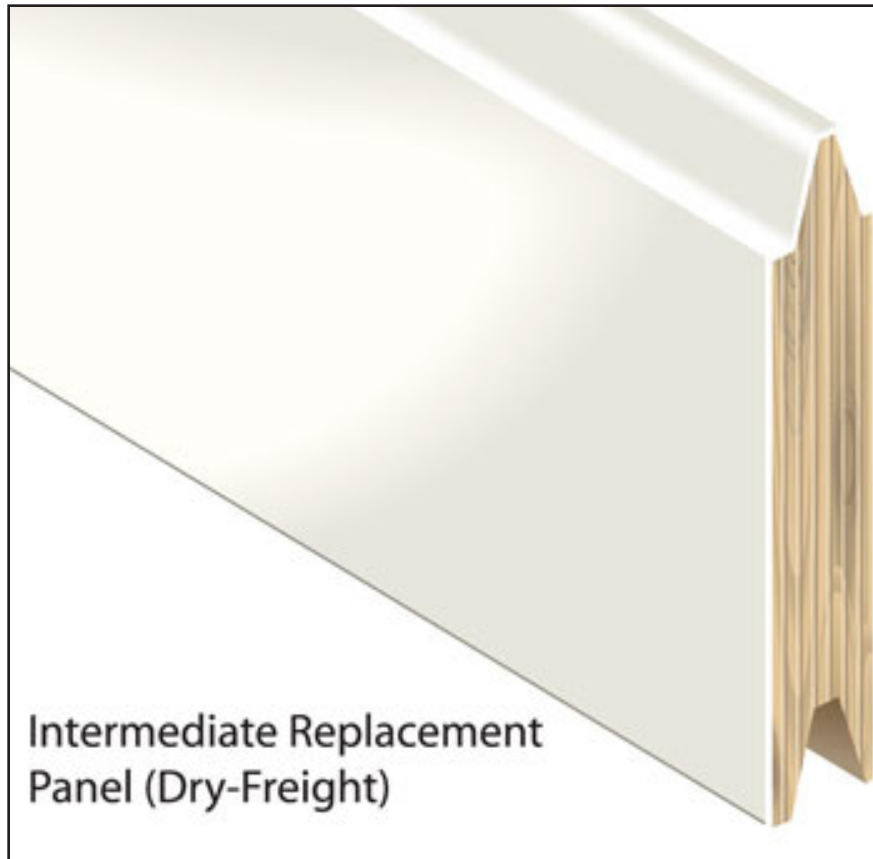

TONGUE & GROOVED W/ ROUTES -SPECIFY SIZE

TG-32110-B	10"-12" x up to 98.25" Intermediate Panel - Primed	TOD29014
TG-32150-B	13"-18" x up to 98.25" Intermediate Panel - Primed	TOD29014
TG-32111-B	10"-12" x up to 98.25" Intermediate Panel - PPW	TOD29014-PPW
TG-32151-B	13"-18" x up to 98.25" Intermediate Panel - PPW	TOD29014-PPW

TONGUE & GROOVED NO ROUTES- SPECIFY SIZE

TG-32110-1B	10"-12" x up to 98.25" Intermediate Panel - Primed	WH342
TG-32150-1B	13"-18" x up to 98.25" Intermediate Panel - Primed	WH342
TG-32111-1B	10"-12" x up to 98.25" Intermediate Panel - PPW	WH342-PPW
TG-32151-1B	13"-18" x up to 98.25" Intermediate Panel - PPW	WH342-PPW

SHIP LAP JOINT - NO ROUTES - SPECIFY SIZE

TG-32110-2B	10"-12" x up to 98.25" Intermediate Panel - Primed	WH242
TG-32150-2B	13"-18" x up to 98.25" Intermediate Panel - Primed	WH242
TG-32111-2B	10"-12" x up to 98.25" Intermediate Panel - PPW	WH242-PPW
TG-32151-2B	13"-18" x up to 98.25" Intermediate Panel - PPW	WH242-PPW

OPTIONS

EXTRA HINGE ROUTES - CUSTOM SIZES
SPECIAL COLORS - PACKAGED 5 PER BOX

BOTTOM PANEL - 1"

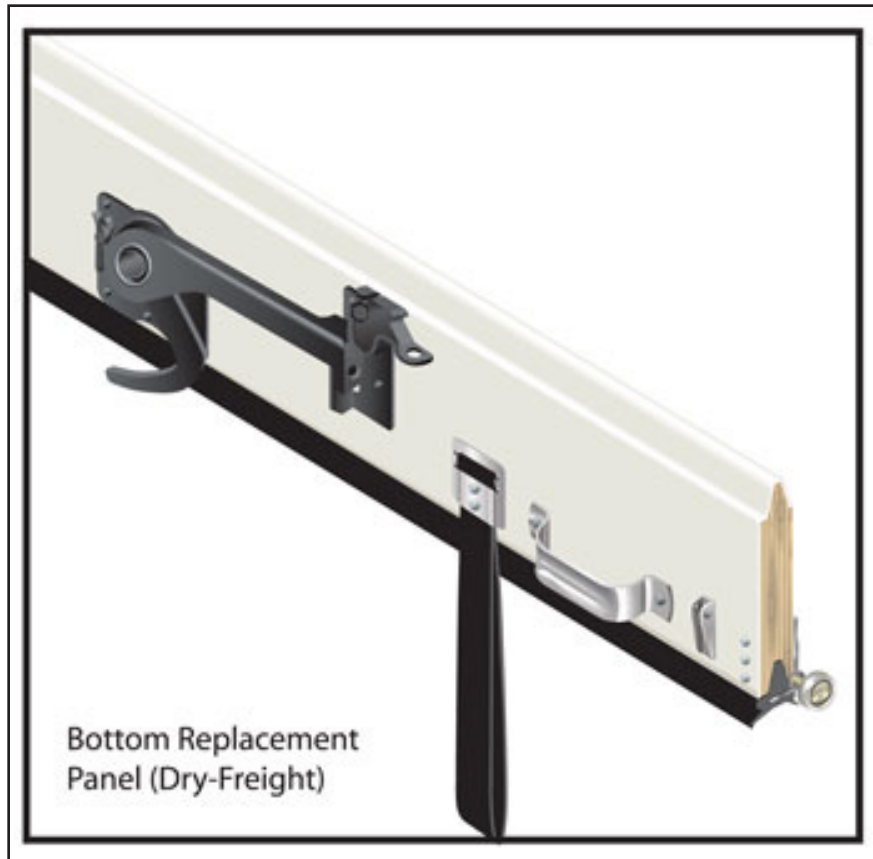

TONGUE & GROOVED W/ ROUTES -SPECIFY SIZE STEEL ANGLE AND SEAL ONLY

TG-33110-B	10"-12" x up to 98.25" Bottom Panel Angle & Seal - Primed	TOD29016
TG-33150-B	13"-18" x up to 98.25" Bottom Panel Angle & Seal - Primed	TOD29016
TG-33111-B	10"-12" x up to 98.25" Bottom Panel Angle & Seal - PPW	TOD29016-PPW
TG-33151-B	13"-18" x up to 98.25" Bottom Panel Angle & Seal - PPW	TOD29016-PPW

TONGUE & GROOVED W/ ROUTES -SPECIFY SIZE

**Steel angle & seal, 1-bottom fixture, 1-cable anchor bracket, pull strap and lift handle attached
1- Cable anchor bracket, 1- bottom fixture -loose**

TG-34110-B	10"-12" x up to 98.25" Bottom Panel W/ Hardware -Angle & Seal - Primed	TOD29016
TG-34150-B	13"-18" x up to 98.25" Bottom Panel W/ Hardware -Angle & Seal - Primed	TOD29016
TG-34111-B	10"-12" x up to 98.25" Bottom Panel W/ Hardware -Angle & Seal - PPW	TOD29016-PPW
TG-34151-B	13"-18" x up to 98.25" Bottom Panel W/ Hardware -Angle & Seal - PPW	TOD29016-PPW

OPTIONS

EXTRA HINGE ROUTES - CUSTOM SIZES, FULLY ASSEMBLED WITH LOCK
SPECIAL COLORS - PACKAGED 2- PER BOX
FORK LIFT PLATE, REINFORCEMENT STRAP, POLAR VENT, PAD-LOCK KEEPER
POWDER COATED WHITE HARDWARE, STAINLESS STEEL RIVETS
INSIDE RELEASE LOCK, SAFETY CHAIN LOCK,
* PANELS CAN BE ASSEMBLED TO MEET ANY SPECIFICATION

BOTTOM PANEL - 2''

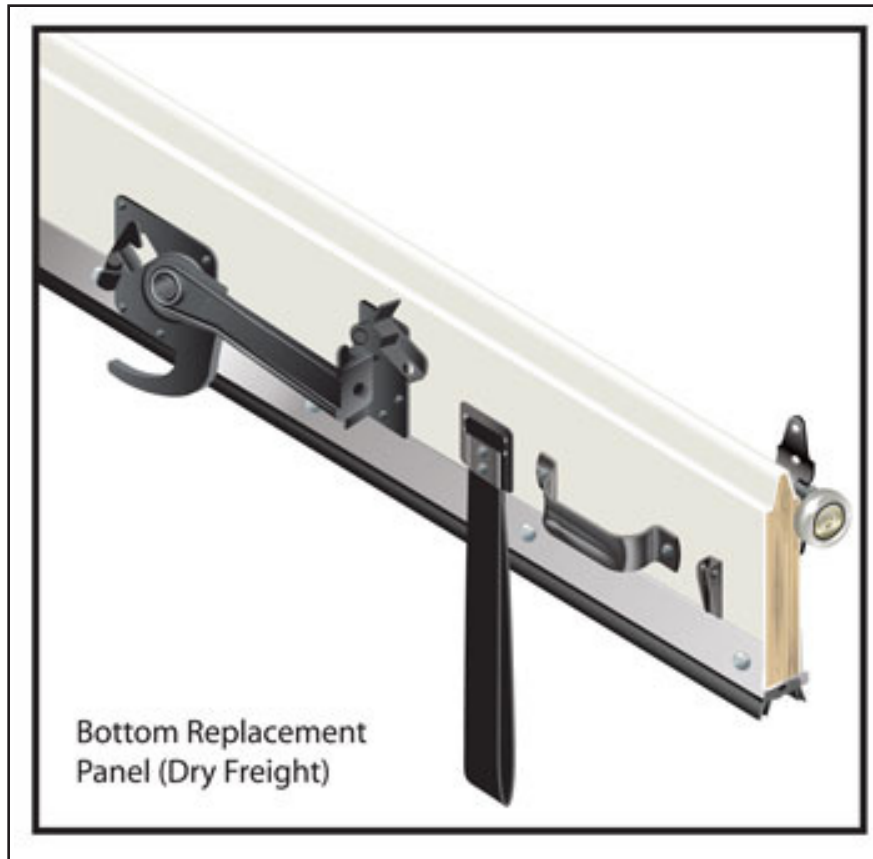

TONGUE & GROOVED NO ROUTES- SPECIFY SIZE ALUMINUM U-CHANNEL AND SEAL ONLY

TG-33110-1B	10''-12'' x up to 98.25'' Bottom Panel Alum Channel & Seal - Primed	WH345
TG-33150-1B	13''-18'' x up to 98.25'' Bottom Panel Alum Channel & Seal - Primed	WH345
TG-33111-1B	10''-12'' x up to 98.25'' Bottom Panel Alum Channel & Seal - PPW	WH345-PPW
TG-33151-1B	13''-18'' x up to 98.25'' Bottom Panel Alum Channel & Seal - PPW	WH345-PPW

TONGUE & GROOVED NO ROUTES- SPECIFY SIZE

Aluminum U-channel & seal, 1-bottom fixture, 1-cable anchor bracket, pull strap and lift handle attached
1- Cable anchor bracket, 1- bottom fixture -loose

TG-34110-1B	10''-12'' x up to 98.25'' Bottom Panel W/ Hardware-Alum Channel & Seal - Primed	WH346
TG-34150-1B	13''-18'' x up to 98.25'' Bottom Panel W/ Hardware Alum Channel & Seal - Primed	WH346
TG-34111-1B	10''-12'' x up to 98.25'' Bottom Panel W/ Hardware-Alum Channel & Seal - PPW	WH346-PPW
TG-34151-1B	13''-18'' x up to 98.25'' Bottom Panel W/ Hardware Alum Channel & Seal - PPW	WH346-PPW

OPTIONS

EXTRA HINGE ROUTES - CUSTOM SIZES, FULLY ASSEMBLED WITH LOCK
SPECIAL COLORS - PACKAGED 2- PER BOX
FORK LIFT PLATE, REINFORCEMENT STRAP, POLAR VENT, PAD-LOCK KEEPER
POWDER COATED WHITE HARDWARE, STAINLESS STEEL RIVETS
INSIDE RELEASE LOCK, SAFETY CHAIN LOCK,
* PANELS CAN BE ASSEMBLED TO MEET ANY SPECIFICATION



*What can “team”
Transglobal do for you?*